



# Panasonic®

## Combination VCR Operating Instructions

Omnivision VHS

### Model No. PV-C2023/PV-C2033W



- Initial Setup and Connection Procedures are on pages 8 and 9.



As an ENERGY STAR® Partner, Matsushita Electric Corporation of America has determined that this product or product model meets the ENERGY STAR® guidelines for energy efficiency.



Please read these instructions carefully before attempting to connect, operate, or adjust this product. Please save this manual. Spanish Quick Use Guide is included. (Guía para rápida consulta en español está incluida.)

Initial Setup

Basic Operation

TV Operation

Timer Operation

Advanced Operation

For Your Information

LSOT0665A

# Important Safeguards and Precautions

**READ AND RETAIN ALL SAFETY AND OPERATING INSTRUCTIONS. HEED ALL WARNINGS IN THE MANUAL AND ON UNIT**

## INSTALLATION

### 1 POWER SOURCE CAUTION

Operate only from power source indicated on unit or in this manual. If uncertain, have your Electric Utility Service Company or Video Products Dealer verify your home power source.

### 2 POWER CORD PLUG

For safety, this unit has a polarized type plug (one wide blade), or a three-wire grounding type plug. Always hold the plug firmly and make sure your hands are dry when plugging in or unplugging the AC power cord. Regularly remove dust, dirt, etc. on the plug.

#### POLARIZED PLUG CAUTION:

The plug fits into outlet one way. If it cannot be fully inserted, try reversing it. If it still will not fit, have an electrician install the proper wall outlet. Do not tamper with the plug.

#### GROUNDING PLUG CAUTION:

The plug requires a three-hole grounding outlet. If necessary, have an electrician install the proper outlet. Do not tamper with the plug.

### 3 POWER CORD

To avoid unit malfunction, and to protect against electrical shock, fire or personal injury:

- Keep power cord away from heating appliances and walking traffic. Do not rest heavy objects on, or roll such objects over the power cord.
- Do not tamper with the cord in any way.
- An extension cord should have the same type plug (polarized or grounding) and must be securely connected.
- Overloaded wall outlets or extension cords is a fire hazard.
- Frayed cords, damaged plugs, and damaged or cracked wire insulation are hazardous and should be replaced by a qualified electrician.

### 4 DO NOT BLOCK VENTILATION HOLES

Ventilation openings in the cabinet release heat generated during operation. If blocked, heat build-up may result in a fire hazard or heat damage to cassettes.

For your protection:

- a. Never cover ventilation slots while unit is ON, or operate unit while placed on a bed, sofa, rug, or other soft surface.
- b. Avoid built-in installation, such as a book case or rack, unless properly ventilated.

### 5 AVOID EXTREMELY HOT LOCATIONS OR SUDDEN TEMPERATURE CHANGES

Do not place unit over or near a heater or radiator, in direct sunlight, etc. If unit is suddenly moved from a cold place to a warm place, moisture may condense in unit and on the tape causing damage.

### 6 TO AVOID PERSONAL INJURY

- Never place unit on support or stand that is not firm, level, and adequately strong. The unit could fall causing serious injury to a child or adult and damage to the unit.
- Move any appliance and cart combination with care. Quick stops, excessive force, and uneven surfaces may cause objects to overturn.
- Carefully follow all operating instructions.



## OUTDOOR ANTENNA INSTALLATION

### 1 SAFE ANTENNA AND CABLE CONNECTION

An outside antenna or cable system must be properly grounded to provide some protection against built up static charges and voltage. Section 810 of the National Electrical Code, ANSI/NFPA 70 (in Canada, part 1 of the Canadian Electrical Code) provides information regarding proper grounding of the mast and supporting structure, grounding of the lead-in wire to an antenna discharge unit, size of grounding conductors, location of antenna discharge unit, connection to grounding electrodes, and requirements for the grounding electrode.

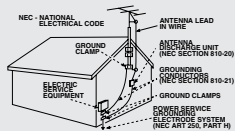

### 2 KEEP ANTENNA CLEAR OF HIGH VOLTAGE POWER LINES OR CIRCUITS

Locate an outside antenna system well away from power lines and electric light or power circuits so it will never touch these power sources should it ever fall. When installing antenna, absolutely never touch power lines, circuits or other power sources as this could be fatal.

## USING THE UNIT

Before unit is brought out of storage or moved to a new location, refer again to the INSTALLATION section of these safeguards.

### 1 KEEP UNIT WELL AWAY FROM WATER OR MOISTURE, such as vases, sinks, tubs, etc.

### 2 IF EXPOSED TO RAIN, MOISTURE, OR STRONG IMPACT, unplug unit and have it inspected by a qualified service technician before use.

### 3 ELECTRICAL STORMS

During a lightning storm, or before leaving unit unused for extended periods of time, disconnect all equipment from the power source as well as the antenna and cable system.

### 4 WHEN UNIT IS PLUGGED IN

#### • DO NOT OPERATE IF:

- liquid has spilled into unit.
- unit was dropped or otherwise damaged.
- unit emits smoke, malodors, or noises.

Immediately unplug unit, and have it inspected by a service technician to avoid potential fire and shock hazards.

- Never drop or push any object through openings in unit. Touching internal parts may cause electric shock or fire hazard.
- Keep magnetic objects, such as speakers, away from unit to avoid electrical interference.

### 5 USING ACCESSORIES

Use only accessories recommended by the manufacturer to avoid risk of fire, shock, or other hazards.

### 6 CLEANING UNIT

Unplug unit. Use a clean, dry, chemically untreated cloth to gently remove dust or debris. DO NOT USE cleaning fluids, aerosols, or forced air that could over-spray, or seep into unit and cause electrical shock. Any substance, such as wax, adhesive tape, etc. may mar the cabinet surface. Exposure to greasy, humid, or dusty areas may adversely affect internal parts.

## SERVICE

### 1 DO NOT SERVICE PRODUCT YOURSELF

If, after carefully following detailed operating instructions, the unit does not operate properly, do not attempt to open or remove covers, or make any adjustments not described in the manual. Unplug unit and contact a qualified service technician.

### 2 REPLACEMENT OF PARTS

Make sure the service technician uses only parts specified by the manufacturer, or have equal safety characteristics as original parts. The use of unauthorized substitutes may result in fire, electric shock, or other hazards.

### 3 SAFETY CHECK AFTER SERVICING

After unit is serviced or repaired, request that a thorough safety check be done as described in the manufacturer's service literature to ensure video unit is in safe operating condition.

# Safety Precautions/Mesures de sécurité

- Warning :** To prevent fire or shock hazard, do not expose this equipment to rain or moisture.
- Caution :** To prevent electric shock, match wide blade of plug to wide slot, fully insert.
- Avertissement :** Afin de prévenir tout risque d'incendie ou de chocs électriques, ne pas exposer cet appareil à la pluie ou à une humidité excessive.
- Attention :** Pour éviter les chocs électriques, introduire la lame la plus large de la fiche dans la borne correspondante de la prise et pousser jusqu'au fond.
- FCC WARNING :** Any unauthorized changes or modifications to this equipment would void the user's authority to operate.

This video recorder, equipped with the HQ (High Quality) System, is compatible with existing VHS equipment. Only use those tapes with the **VHS** mark. It is recommended that only cassette tapes that have been tested and inspected for use in 2, 4, 6, and 8 hour VCR machines be used. This television receiver provides display of television closed captioning in accordance with §15.119 of the FCC rules.

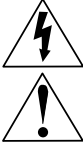

This symbol warns the user that uninsulated voltage within the unit may have sufficient magnitude to cause electric shock. Therefore, it is dangerous to make any kind of contact with any inside part of this unit.

This symbol alerts the user that important literature concerning the operation and maintenance of this unit has been included. Therefore, it should be read carefully in order to avoid any problems.

This product utilizes both a Cathode Ray Tube (CRT) and other components that contain lead. Disposal of these materials may be regulated in your community due to environmental considerations. For disposal or recycling information please contact your local authorities, or the Electronics Industries Alliance: <<http://www.eiae.org>>

## Congratulations

On your purchase of one of the most sophisticated and reliable products on the market today. Used properly, it will bring you and your family years of enjoyment. Please fill in the information below. The serial number is on the tag located on the back of your unit.

Date of Purchase \_\_\_\_\_

Dealer Purchased From \_\_\_\_\_

Dealer Address \_\_\_\_\_

Dealer Phone No. \_\_\_\_\_

Model No. \_\_\_\_\_

Serial No. \_\_\_\_\_

## Accessories

- Remote Control

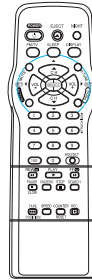

LSSQ0380  
(PV-C2023)

LSSQ0384  
(PV-C2033W)

- Batteries 2 "AA"

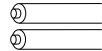

To order accessories,  
call toll free 1-800-332-5368.

## Loading the Batteries

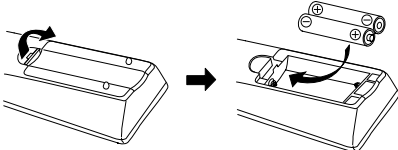

Battery replacement caution

- Do not mix old and new batteries.
- Do not mix alkaline with manganese batteries.

## Prevent Accidental Tape Erasure

Break off the tab to prevent recording.

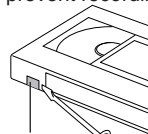

Record Tab  
Screwdriver

To record again.

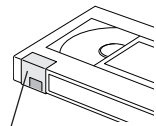

Cover the hole with cellophane tape.

# Unit Information

## Head Cleaning

Playing older or damaged tapes may eventually cause video heads to become clogged.

### Head Clog Sensor

During playback this screen appears if clogging is detected. To remove screen, press PLAY on the remote or unit.

V I D E O H E A D S M A Y  
N E E D C L E A N I N G  
P L E A S E I N S E R T H E A D  
C L E A N I N G C A S S E T T E  
O R R E F E R T O M A N U A L

END:PLAY

- Use "dry" type head cleaning cassette only. (Part No. NV-TCL30PT is recommended.)
- Follow cleaning tape directions carefully. Excessive use of head cleaning tape can shorten the video head life.

## Features for a Quality Picture

### Digital Auto Tracking

Continuously analyzes the signal and adjusts for optimum picture quality.

### Manual Tracking Control (to reduce picture noise)

Use during Playback and Slow Motion mode to reduce picture noise. Press the 3 or 6 number key on the remote control or CH ▲▼ on the unit until the picture clears up. To return to Auto Tracking, press POWER off, then on again a few seconds later.

## Record/Playback Time

Only use tapes with the **VHS** mark in this unit.

Tape Speed Setting	Type of Video Cassette		
	T60	T120	T160
SP (Standard Play)	1 Hour	2 Hours	2 Hours 40 Minutes
LP (Long Play)	2 Hours	4 Hours	5 Hours 20 Minutes
SLP (Super Long Play)	3 Hours	6 Hours	8 Hours

## Specifications

<b>Display</b>		
Picture Tube	20 inch measured diagonal 90° deflection Picture Tube	
<b>VCR</b>		
Video Recording System	2 rotary heads helical scanning system	
Audio Track	1 track	
<b>Tuner</b>		
Broadcast Channels	VHF 2 ~ 13, UHF 14 ~ 69	
CABLE Channels	Midband A through I (14 ~ 22) Superband J through W (23 ~ 36) Hyperband AA ~ EEE (37 ~ 64) Lowband A-5 ~ A-1 (95 ~ 99) Special CABLE channel 5A(01) Ultraband 65 ~ 94, 100 ~ 125	
<b>FM Radio</b>		
Band Range	87.5 MHz ~ 108.1 MHz	
<b>General</b>		
Power Source	120 V AC, 60 Hz	
Power Consumption	Power On	Approx. 110 W
	Power Off	Approx. 2.5 W
Television System	EIA Standard NTSC color	
Speaker	1 pieces	
Operating Temperature	5 °C ~ 40 °C (41 °F ~ 104 °F)	
Operating Humidity	10 % ~ 75 %	
Weight	23 Kg (50.6 lbs.)	
Dimensions (W X H X D)	515 mm (20-5/16") X 505 mm (19-7/8") X 474 mm (18-11/16")	

### Note

- Designs and specifications are subject to change without notice.

## DST (Daylight Saving Time)

Unit auto adjusts clock for DST (Daylight Saving Time.)

### ■ Spring (First Sunday in April)

DST: ON → Sets clock ahead one hour.

### ■ Autumn (Last Sunday in October)

DST: OFF → Turns clock back one hour.

- If your area does not observe Daylight Saving Time, select DST: OFF.
- Keep these time changes in mind when programming the unit for timer recordings.

# Table of Contents

Important Safeguards and Precautions .....	2
Safety Precautions/Mesures de sécurité.....	3
Unit Information.....	4
Location of Controls .....	6
Connections/Initial Setup (Ready to Play) .....	8
<hr/>	
Reset Language, Channels, Clock, Time Zone Adjust.....	10
Playback a Tape.....	12
Record On a Tape.....	12
Copy Your Tapes (Dubbing).....	13
<hr/>	
TV Operation.....	14
Picture Adjustment.....	15
TV Timer Features .....	16
Closed Caption System .....	18
FM Radio .....	20
<hr/>	
Timer Recording.....	22
<hr/>	
Tape Operation .....	24
Special VCR Features .....	28
V-Chip Control Feature .....	29
<hr/>	
On-Screen Display (OSD) .....	32
Before Requesting Service.....	33
Limited Warranty .....	34
Customer Services Directory .....	35
Spanish Quick Use Guide/Guía para rápida consulta.....	36
Index .....	40

Initial Setup

Basic Operation

TV Operation

Timer Operation

Advanced Operation

For Your Information

# Location of Controls

## Remote Control Buttons

### EJECT

Ejects tape.

### POWER

Turns on or off the unit.

### FM/TV

Receives FM radio signal.

### MUTE

Mutes the sound instantly.

### CHANNEL UP/DOWN

Selects a channel.

### SELECT UP/DOWN

Controls navigation around on-screen menu.

### ACTION

Displays Main Menu.

### NUMBER Keys

Selects a channel directly.

### PLAY

Begins playback.

### REWIND/SEARCH

Rewinds tape, and searches reverse scene.

### PAUSE/SLOW

Pauses and slow motion and frame advance picture.

### CM SKIP/ZERO SEARCH

In Stop mode, goes to the counter "0:00:00." In Play mode, skips over 1 to 3 minutes of tape.

### TAPE POSITION

Finds out present tape position and amount of tape remaining.

### SPEED

Selects recording speed.

### SLEEP

Turns off the unit automatically.

### NIGHT

Color and picture intensity level are adjusted during night time use.

### DISPLAY

Displays the VCR status and clock.

### RAPID TUNE

Displays the last channel you were watching.

### VOLUME UP/DOWN

Adjusts volume.

### SET/BACK SPACE

Sets a selected menu, or goes back to correct.

### PROGRAM

Displays SET PROGRAM screen. You can set Timer Program and On-Timer.

### TRACKING UP/DOWN

Reduces picture noise during Playback and Slow Motion.

### ADD/DELETE

Adds or deletes a channel.

### FAST FORWARD/SEARCH

Fast forwards tape, and searches forward scene.

### SEARCH

Goes directly to the desired recording. Locates end point of recording.

### STOP

Stops recording or playback.

### REC

Records the program.

### COUNTER RESET

Resets to "0:00:00" at the desired position.

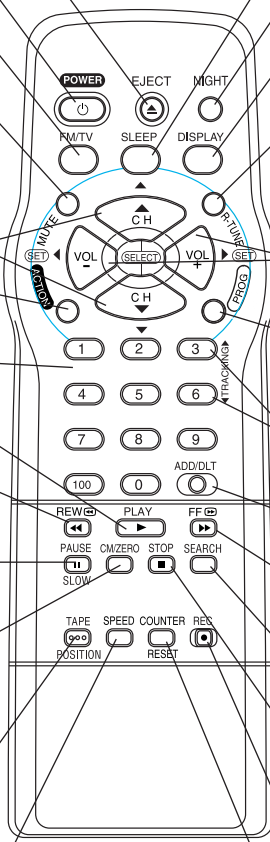

### Note

- When EJECT is pressed, the tape is ejected from Cassette Compartment. If EJECT is pressed during recording, the unit will not respond to the command.

## Front View of the Unit and Indicators

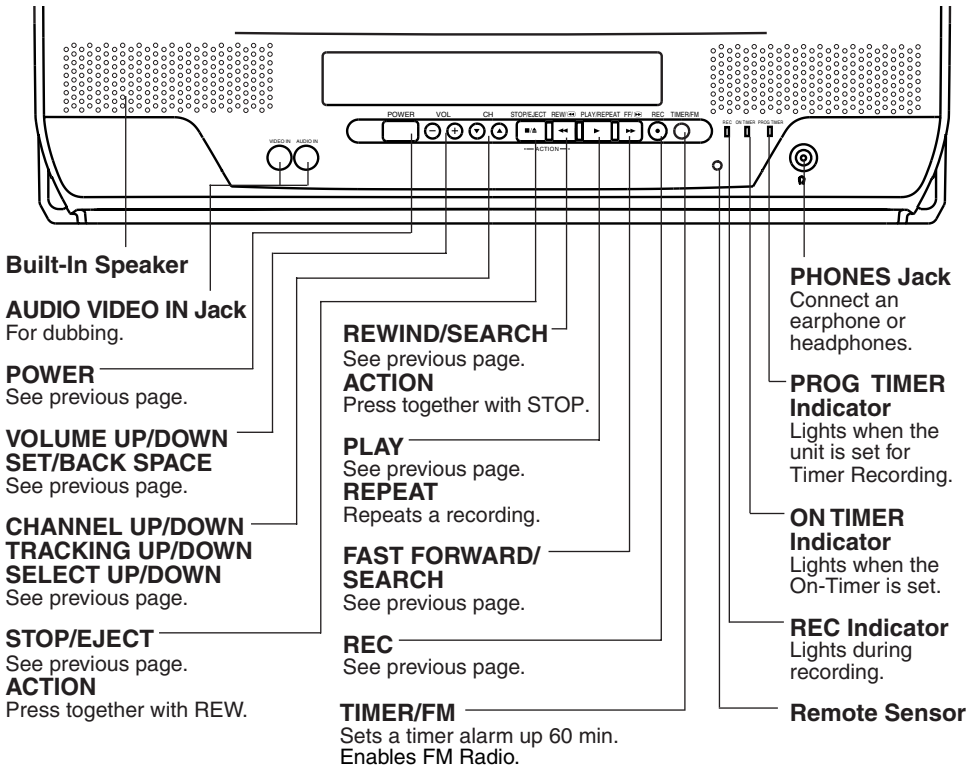

## Rear View of the Unit

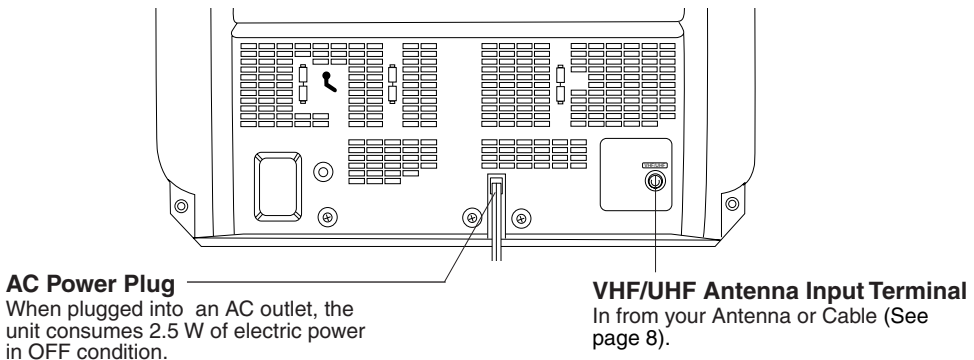

# Connections/Initial Setup (Ready to Play)

Please make all cable or antenna connections before power on.

## Connecting

### For ANT./Cable

Connect the cable from Antenna/Cable to the VHF/UHF terminal on the unit.

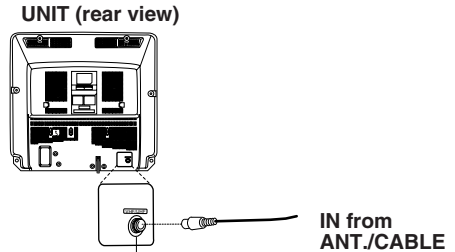

### For DSS/Cable Box

Connect the OUT jack on your cable box to the VHF/UHF terminal on the unit with a RF cable.

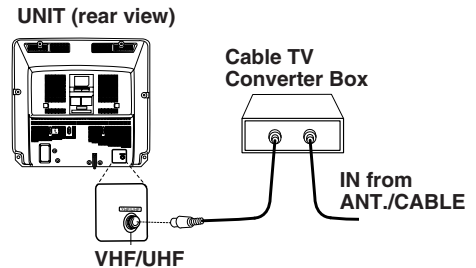

### WARNING:

Overtightening "Nut type" RF coaxial cables may damage jacks. Finger tighten only.

## Initial Setup (Ready to Play)

Press **COMBO** on the remote for Combo mode.

**1** Plug the unit power cord into AC wall outlet.

**2** Press **POWER** on the remote or unit. The unit comes on and auto channel and clock set starts.

- If you use a cable box, turn it on and set it to the Public Broadcasting Service (PBS) channel in your time zone. If you use a DSS receiver, it must be turned off.

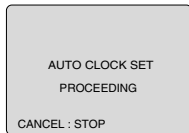
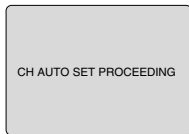

**3** Settings are made automatically. When setup is done, this screen appears.

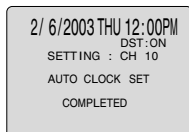

If **AUTO CLOCK SET IS INCOMPLETE** screen appears, set the clock using **MANUAL CLOCK SET** procedure on next page.

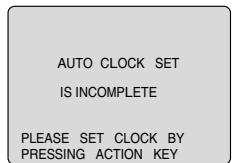

### Notes

- Function buttons are inoperative during Initial Setup.
- To remove a cassette during Auto Set, press **EJECT** twice on the remote or **STOP** twice on the unit. In this case, settings must be made manually. (See page 10.)
- Depending on conditions, Auto Clock Set may take longer than 30 minutes. If so, press **STOP** to stop setup and perform settings manually. (See page 10.)



## Manual Clock Set

If AUTO CLOCK SET was incomplete, manually set the clock as follows.

- 1 Press **ACTION** on the remote to display SET CLOCK Menu screen.

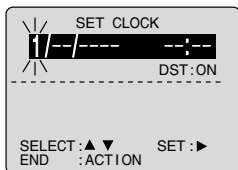

- 2 Press ▲ ▼ to select the month and press ► to set. In the same manner, select and set the date, year, time, and DST. (Daylight Saving Time)



- 3 Press **ACTION** twice to start CLOCK and exit.

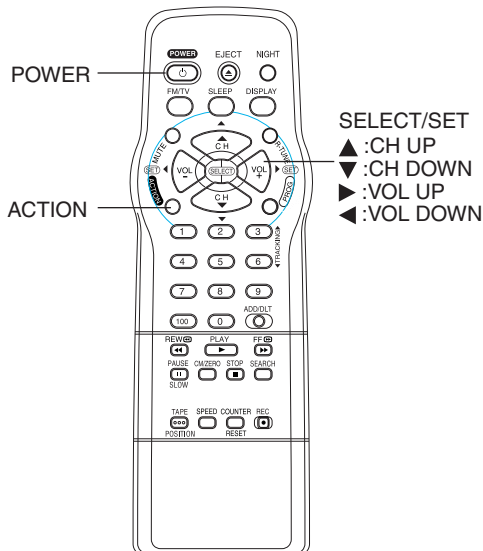

## Reset all unit Memory Functions

When moving unit to a new location, or if a mistake was made in the Initial Setup section.

- Make sure a tape is not inserted in the unit.

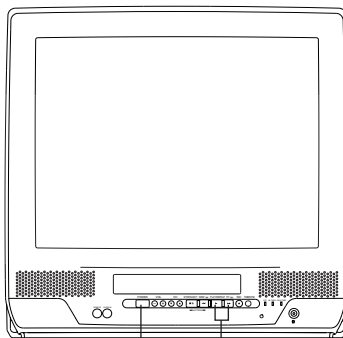

- 1 Turn the unit Power on.
- 2 Press and hold both **PLAY/REPEAT** and **FF** on the unit for more than 5 seconds.
  - The power will shut off.
  - Please ignore "NO CASSETTE" warning.
- 3 Do "Initial Setup" on page 8.

### Note to CABLE System Installer

This reminder is provided to call the CABLE (Cable TV) System Installers attention to Article 820-40 of the NEC that provides guidelines for proper grounding and, in particular, specifies that the cable ground shall be connected to the grounding system of the building, as close to the point of cable entry as practical.

# Reset Language, Channels, Clock,

1

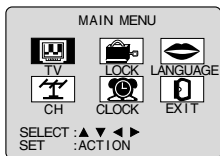

Press **ACTION** to display MAIN MENU.

2

## Language

- 1) Press ▲▼◀▶ to select language icon.

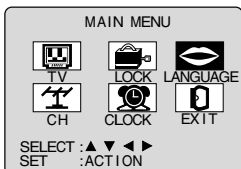

- 2) Press **ACTION** repeatedly.



For Spanish

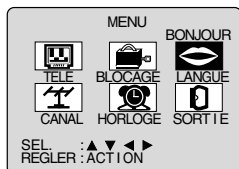

For French

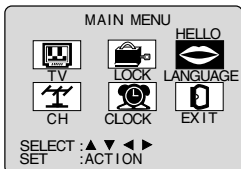

For English

- 3) Press ▲▼◀▶ to select "EXIT." Press **ACTION** to exit.

## Channels

- 1) Press ▲▼◀▶ to select "CH."

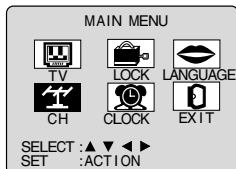

- 2) Press **ACTION**.

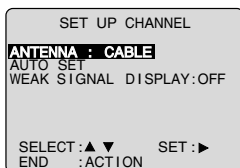

- 3) Press ▲▼ to select "ANTENNA," then press ▶ to set your antenna system ("TV" or "CABLE").
- 4) Press ▲▼ to select "AUTO SET," then press ▶.

• After Channel Auto Set is finished, Clock Auto Set will be performed. (If clock is set manually, Clock Auto Set will not be performed.)

## Clock

- 1) Press ▲▼◀▶ to select "CLOCK."

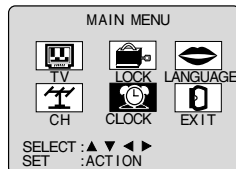

- 2) Press **ACTION**.

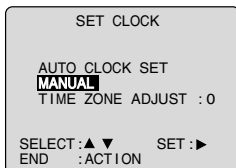

("TIME ZONE ADJUST" appears only when auto clock is set.)

- 3) Press ▲▼ to select "MANUAL" or "AUTO CLOCK SET" and press ▶.
- For Auto Clock Set, select "AUTO CLOCK SET," then press ▶.

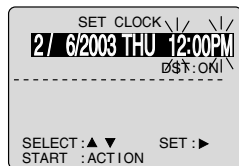

- 4) Press ▲▼ and press ◀▶ to select and set the month, date, year, time, and DST (Daylight Saving Time).
- 5) Press **ACTION** twice to start the clock and exit this mode.

# Time Zone Adjust

## Time Zone Adjust

(Only when Auto Clock is set.)

- 1) Press **▲▼◀▶** to select "CLOCK."

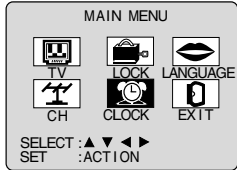

- 2) Press **ACTION**.

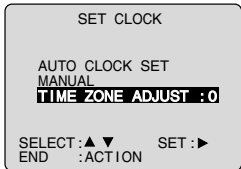

- 3) Press **▲▼** to select TIME ZONE ADJUST and **press ▶** repeatedly to select mode. (See below.)

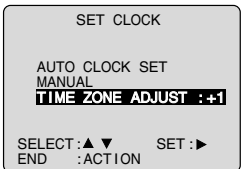
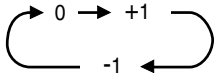

- 4) Press **ACTION** twice to exit.

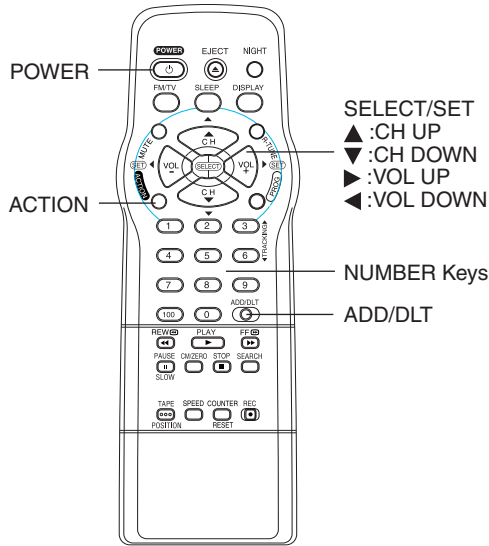

### ACTION key on the unit

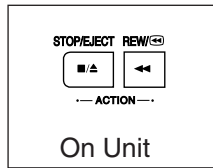

You can operate the menu screen using unit buttons. To display the menu, press STOP/EJECT and REW together with no tape inserted. To exit the menu, repeat above with or without tape inserted until normal screen appears.

### Using ▲▼◀▶ keys

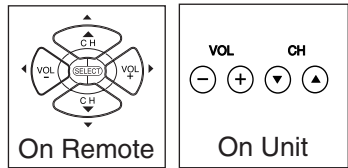

- ▲ : CH UP
- ▼ : CH DOWN
- ▶ : VOLUME UP
- ◀ : VOLUME DOWN

Whenever the menu or program screen is displayed, CHANNEL UP/DOWN function as ▲▼ and VOLUME UP/DOWN function as ◀▶ only.

### Add or Delete a Channel

To add channel: Select channel with number keys and press ADD/DLT.

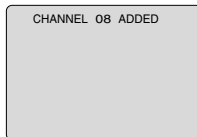

To delete channel: Select channel with CH ▲▼ or number keys and press ADD/DLT.

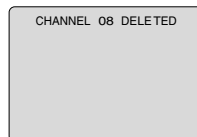



# Copy Your Tapes (Dubbing)

Connections you'll need to make.

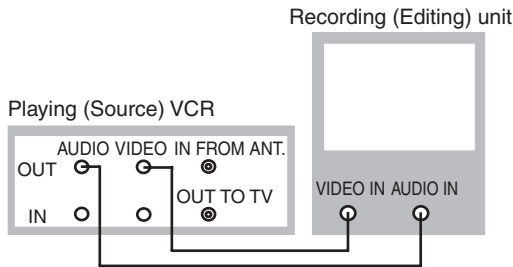

## Playback (Source)

## Recording (Editing) unit

**1**  **Insert pre-recorded tape.**

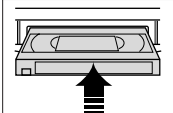
 **Insert blank tape with record tab.**  
 • Dubbing tapes protected with Copy Guard will have poor quality results.

**2** \_\_\_\_\_ **Select "LINE" mode.**  
 See "Selecting Input Mode" below.

**3**  **Press PLAY then PAUSE** at starting point to put in Standby mode.

 **Press REC, then PAUSE/SLOW** immediately to put in Standby mode.

**(Perform operation of steps 4 and 5 on both units at same time.)**

**4**  **Press PLAY** to start dubbing.

 **Press PAUSE/SLOW** to start dubbing.

**5**  **Press STOP** to stop dubbing.

 **Press STOP** to stop dubbing.

### Caution

- Unauthorized exchanging and/or copying of copyrighted recordings may be copyright infringement.

## Selecting Input Mode

**Method 1:**

Press **CH ▲▼**. The display will change as follows.

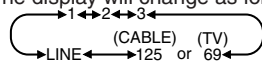

**Method 2:**

- Press **ACTION** for MAIN MENU.
- Press **▲▼◀▶** to select "TV," then press **ACTION** for SET UP TV screen.
- Press **▲▼** to select "INPUT SELECT," and then press **▶** to select "TUNER" or "LINE."
- Press **ACTION** twice to exit this mode.

# TV Operation

- 1** Press **POWER** on the remote or unit.

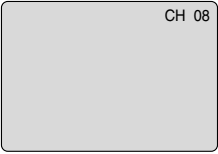
**2**  **Use CH ▲▼ or number keys to select a channel.**

**3**  **Press VOL + or VOL - to adjust volume.**

## NIGHT Mode

Color and picture intensity levels are adjusted so the screen is easier on your eyes during night time use.

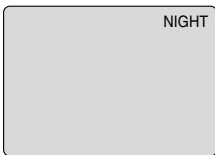

**Press NIGHT to set NIGHT mode.**

- NIGHT mode may be selected when watching TV or playing a tape.

**Press NIGHT to cancel.**

- Previous settings are restored.
- NIGHT mode is canceled when power is turned off or power failure occurs.

## Ready Check List

- All connections are made.
- Your unit is plugged in.

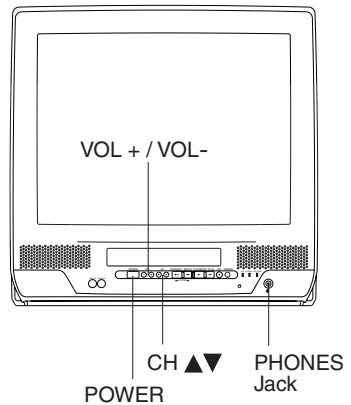

## ■ Using the 100 key

When selecting CABLE channels 100 to 125 with the number keys, first press the 100 key, and then enter the remaining two digits.

## ■ Rapid Tune

Press R-TUNE to display the last channel you were watching.

## ■ Audio Mute

Press MUTE to instantly mute the sound. Press again to restore the previous sound level.

## ■ Phones

Connect an earphone (not supplied) or headphones (not supplied) to the Phones Jack.

# Picture Adjustment

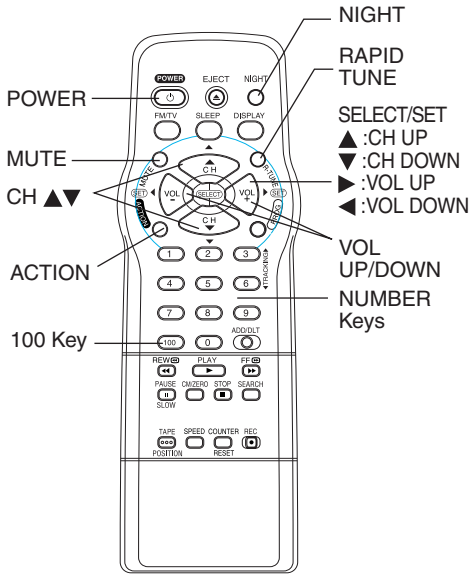

## Picture Adjustment

- **COLOR Control**  
Adjust color intensity.
- **TINT Control**  
Adjust for natural flesh tones.
- **BRIGHTNESS Control**  
Adjust picture brightness.
- **PICTURE Control**  
Adjust picture intensity by adjusting both contrast and color level in the proper balance.
- **SHARPNESS Control**  
Adjust picture sharpness.

**1** Press **ACTION** to display MAIN MENU.

**2**

MAIN MENU		
TV	LOCK	LANGUAGE
CH	CLOCK	EXIT
SELECT : ▲▼◀▶		
SET : ACTION		

- 1) Press ▲▼◀▶ to select "TV."
- 2) Press **ACTION** to display SET UP TV screen.

**3**

SET UP TV	
CAPTION	: TUNER
INPUT SELECT	: EXT
<b>VIDEO ADJUST</b>	
FM ANTENNA	
SELECT : ▲▼	
SET : ►	
END : ACTION	

- 1) Press ▲▼ to select VIDEO ADJUST.
- 2) Press ► to display screen.

**4**

<b>COLOR</b>	..... .....
TINT	..... .....
BRIGHTNESS	..... .....
PICTURE	..... .....
SHARPNESS	..... .....
NORMAL	
SELECT : ▲▼	
ADJUST : ◀▶	
END : ACTION	

- 1) Press ▲▼ to select an adjustment item. (See below left.)
- 2) Press ◀▶ to adjust.

COLOR	..... .....
TINT	..... .....
BRIGHTNESS	..... .....
PICTURE	..... .....
SHARPNESS	..... .....
<b>NORMAL</b>	
SELECT : ▲▼	
SET : ►	
END : ACTION	

**To Reset Picture Controls,**  
press ▲▼ and ► to select and set "NORMAL."  
All controls return to their factory settings.

**5** Press **ACTION** three times to exit.

# TV Timer Features

## ON-TIMER with Alarm

This unit can be set to automatically power on in one of 3 modes (TV, Playback, or FM radio). You can also combine the On-Timer with a one minute alarm that gradually increases in volume.

## Ready Check List

- The clock is set to the correct time.

**1** Press **PROG** to display SET PROGRAM screen.

**2**

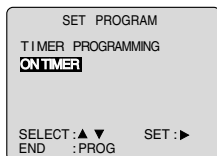

- 1) Press **▲▼** to select "ON TIMER."
- 2) Press **▶** to display ON TIMER screen.

**3**

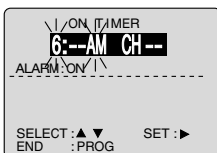

- 1) Press **▲▼** to select desired settings.
- 2) Press **▶** to set the ON-TIMER TIME or ON-TIMER mode.

- Make sure a tape is inserted if Playback mode is selected.
- See "FM Radio" on pages 20 and 21 for instructions on how to preset FM stations.

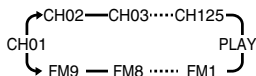

• ON-TIMER mode selection order

**4**

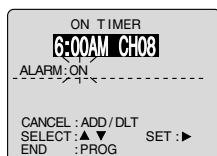

Press **▲▼** to select ALARM "ON" or "OFF."

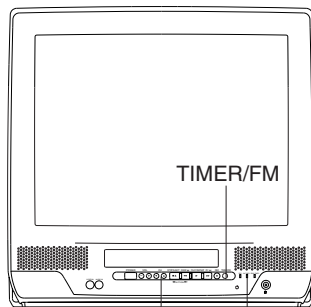

CH **▲▼** ON TIMER indicator

**When "ON" is selected**, an alarm will gradually increase in volume for one minute or until canceled by pressing any button (including VOL + -).

**To Make Corrections**, use **▲▼** and **◀▶** to move back and correct.

**5** Press **PROG** to set ON TIMER.

- "ON TIMER SET" is displayed.
- ON TIMER Indicator lights on the unit.

**To Cancel ON-TIMER**,

Repeat steps 1 and 2. Then, **press ADD/HLT** to clear the time in step 3. Now, **press PROG** to end.

"ON TIMER END" briefly appears on-screen.

### Note

- If no button on the remote or unit (including a button used to turn off the alarm) is pressed within 60 minutes after unit turns itself on, it will turn itself back off.



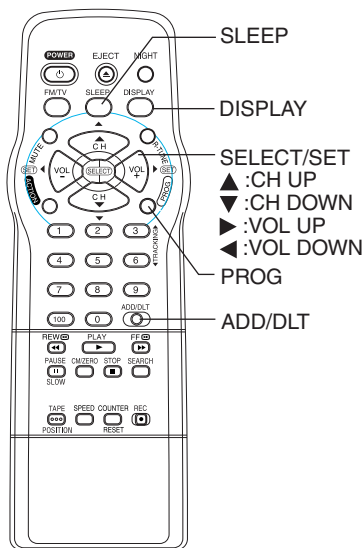

## Sleep Timer

This unit can be set for auto power off.

Press **SLEEP** repeatedly to set SLEEP TIMER.

• Pressing **DISPLAY** with sleep timer set displays remaining time.

Press **SLEEP** repeatedly until "SLEEP TIMER 00" appears to cancel.

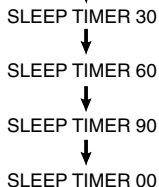

## Instant Alarm

You can set a timer alarm up to 60 min. Useful when you are cooking, etc.

**1** Press **TIMER/FM** on the unit to display the instant alarm CANCEL/SET screen.

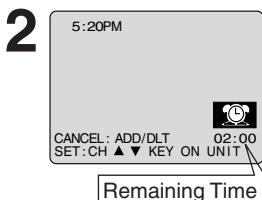

Press **CH ▲▼** on the unit with CANCEL/SET screen displayed to set alarm. (Time changes in the order shown left.)

• Pressing **TIMER/FM** repeatedly on the unit will change display as follows.

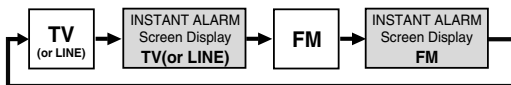

**To cancel**, press **TIMER/FM** then press **ADD/HLT** on the remote while CANCEL/SET screen is displayed.

**To increase timer in progress**, repeat step 2. Time will be rounded up to next 1, 5, or 10 minute interval. (See chart left.)

<Example>

- If current time remaining is 12:15, countdown will restart from 15:00.
- If current time remaining is 9:15, countdown will restart from 10:00.

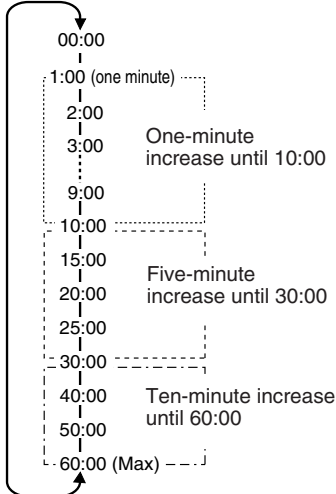

### Note

- While timer function is in progress, you can change channels on the unit with **CH ▲▼** while "CANCEL/SET" screen is not displayed.

**3** Alarm will sound at 0:00. Press any button to stop.

- The volume of the alarm gradually increases for one minute and then continues to beep until any button is pressed.

# Closed Caption System

## Closed Caption is ...

This multi-use system not only allows the hearing impaired to enjoy selected programs, but also makes useful information from TV stations available to everyone.

### Closed Caption Mode Feature

**1** Press **ACTION** to display MAIN MENU.

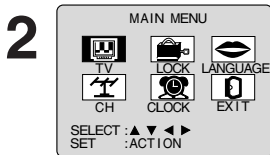

- 1) Press **▲▼◀▶** to select "TV."
- 2) Press **ACTION** to display SET UP TV screen.

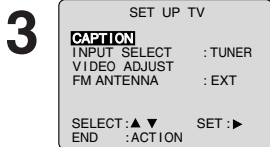

- 1) Press **▲▼** to select "CAPTION."
- 2) Press **▶** to display CAPTION screen.

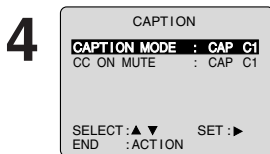

- 1) Press **▲▼** to select CAPTION MODE.
- 2) Press **▶** repeatedly to select mode. (See left.)



**5** Press **ACTION** three times to return to the normal screen.

### Closed Caption Mode Selections

#### Caption Mode: CAP C1 or C2

A narration of selected TV programs is displayed. Check TV program listings for CC (Closed Caption) broadcasts.

#### Caption Mode: TEXT C1 or C2

The lower half of the screen will be blocked out. When the TV station broadcasts information, such as program listings, it will appear in this space.

#### Caption Mode: OFF

Closed Caption / Text narration will not be displayed.

#### NOTES :

- The closed caption or text signal may be broadcast over C1, C2, or both. Also, text contents can vary so you may wish to try different settings.
- While recording of one station and watching another is being done, Captioning will not be displayed.

### Recording and Playing Back a Closed Caption/Text Program

**Record:** Record normally. Closed Caption/ Text signal, if present, is recorded automatically.

**Playback:** Start playback. Do above steps to select desired caption mode.

## Caption On Mute Feature

Closed Caption narration, if available, is displayed when MUTE button is pressed for silence.

**1** Press **ACTION** to display MAIN MENU.

**2**

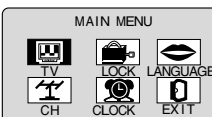

1) Press **▲▼◀▶** to select "TV."  
2) Press **ACTION** to display SET UP TV screen.

**3**

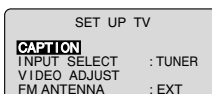

1) Press **▲▼** to select "CAPTION."  
2) Press **▶** to display CAPTION screen.

**4**

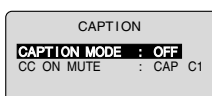

1) Press **▲▼** to select CAPTION MODE.  
2) Press **▶** repeatedly to select "OFF."

**5**

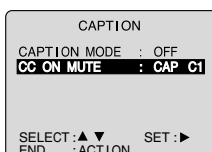

1) Press **▲▼** to select CC ON MUTE.  
2) Press **▶** repeatedly to select desired mode.

- Each press of **▶** will change the display as shown left.
- The caption may be broadcast over CAP C1 or C2.

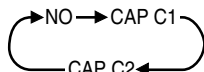

**6** Press **ACTION** three times to return to the normal screen.

**7** Press **MUTE** to mute the sound and display closed captioning.

- To cancel, press **MUTE** again.

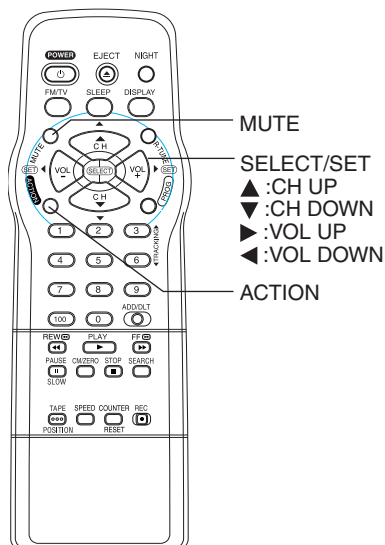

# FM Radio

## FM Radio is ...

This unit has an FM radio with built-in antenna, 9 station preset, and a band range of 87.5 ~ 108.1 MHz. You can even set the On-Timer (page 16) to wake up to your favorite radio station.

### FM Radio Setup

- 1 Press **FM/TV** on the remote or **press TIMER/FM** twice on the unit to display FM radio mode.

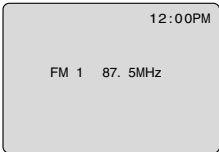
- 2  Press a number key (1~9) to select the FM number.

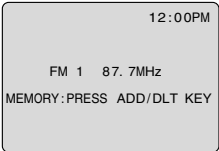
- 3  1) Press **CH ▲▼** to select the desired radio station. (Each press changes frequency 200 kHz.)

- 2) Press **ADD/HLT** to set the radio station.

Hold down **CH ▲** or **▼** for a few seconds, then release to quickly scan for FM stations in your area.

- To cancel, **press CH ▲** or **▼** while in search mode.

#### To Make Corrections,

select station with a number key, then do step 3 again.

#### To exit FM mode,

press **FM/TV** on the remote or **TIMER/FM** twice on the unit.

### FM ANTENNA Setup

Make sure FM tuning is done correctly (see FM Radio Setup).

- 1 Press **ACTION** to display MAIN MENU.

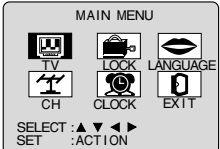
- 2  1) Press **▲▼◀▶** to select "TV."  
2) Press **ACTION** to display SET UP TV screen.

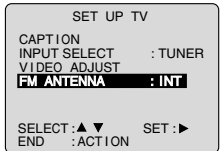
- 3  1) Press **▲▼** to select FM ANTENNA.  
2) Press **▶** to select "INT (INTERNAL)" or "EXT (EXTERNAL)" whichever sounds the best.
- For cable TV users → "INT"
  - For antenna users → "EXT"

- 4 Press **ACTION** twice to end setup.

## How to use the FM radio

- 1 Press **FM/TV** on the remote or press **TIMER/FM** twice on the unit to display FM radio mode.

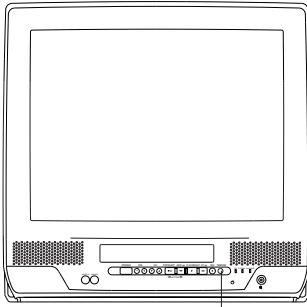

TIMER/FM

2



Press a **Number key (1~9)** to select a preset FM number (see “FM Radio Setup”).

To cancel, press **FM/TV** on the remote or **TIMER/FM** twice on the unit.

### Notes

- FM radio cannot be recorded on a Video cassette.
- You may get better reception by repositioning the unit.
- You cannot select FM Radio mode during playback or record, or while a blue back screen (PROG, ACTION, MENU) is displayed.
- Once stations are set, the selected station and current time are displayed when FM Radio mode is entered. To remove time, press DISPLAY. If DISPLAY is pressed again, the unit status screen appears.

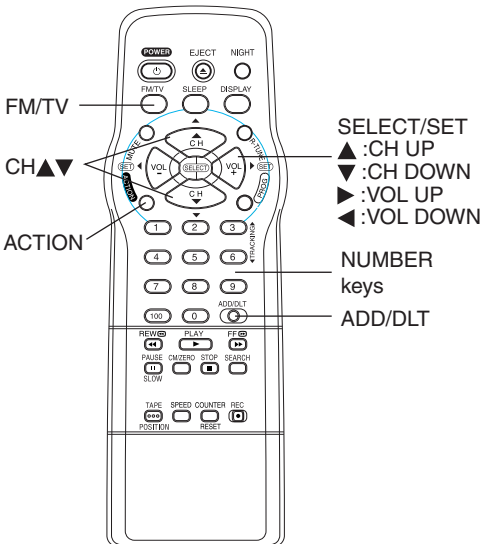

# Timer Recording

You can set up to 8 programs to be recorded while you are away.

**1** Press **PROG** to display SET PROGRAM screen.

**2**

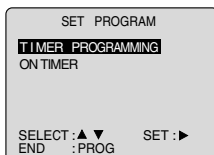

1) Press **▲▼** to select **TIMER PROGRAMMING**.  
2) Press **►** to display screen.

• If a program is already in memory, press **▲▼**, and **►** to select an unused program number.

**3**

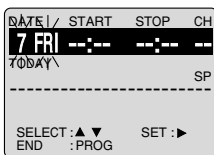

Press **▲▼** to select and **►** or **◀** to set the

recording DATE.  
• 1~31 = One time  
• DAILY = MON~FRI  
• WEEKLY SUN~SAT = Same time once a week

## Example

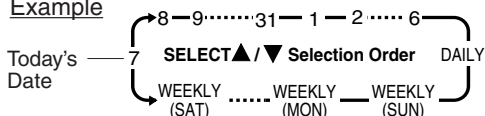

## Repeat step 3 to set:

- Start time, Stop time
- Channel (or LINE for outside source)
- Speed (SP, LP, SLP)

**4**

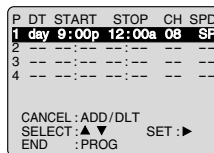

Press **PROG** to end the program.

**To Enter More Programs**, press **▲▼** to select and **►** to set a blank program number, and then repeat step 3.

**5**

- Press **PROG** twice to exit this mode.
- If you're using a cable box, make sure that it is tuned to the desired channel and the power is left on for timer recording.
  - PROG TIMER indicator lights on the unit.

## Ready Check List

- All connections are made.
- Your unit is plugged in.
- The clock is set to correct time.
- The tape is long enough.
- The record tab is in place.

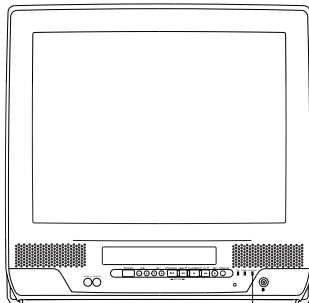

PROG TIMER indicator

## Cancel a Timer Recording: (Recording is in progress)

Hold down STOP for a few seconds to cancel the Timer Recording.

- Any future daily or weekly recordings will be performed as programmed.

## Review, Replace or Clear Program Contents : (Recording is not in progress)

**1** Repeat steps 1 and 2 on page 22.

**2**

P	DT	START	STOP	CH	SPD
1	day	9:00p	12:00a	08	SP
2	8	10:00a	12:00p	125	SP
3	10	8:00p	9:00p	10	SP
4	SU	9:00p	10:00p	L	LP

CANCEL : ADD/DLT  
SELECT : ▲ ▼ SET : ▶  
END : PROG

Press ▲▼ to select the desired program.

**3** To Replace program...

DATE	/	START	STOP	CH
8 SAT		9:00P	12:00A	08
70DAY\				
SP				

SELECT : ▲ ▼ SET : ▶  
END : PROG

- Press ▶ to display.
- Press ▲▼ to select and press ◀ or ▶ to set new program contents.
- Press PROG.

To Clear program...

P	DT	START	STOP	CH	SPD
1	---	---	---	---	---
2	8	10:00p	12:00a	125	SP
3	10	8:00p	9:00p	10	SP
4	SU	9:00p	10:00p	L	LP

CANCEL : ADD/DLT  
SELECT : ▲ ▼ SET : ▶  
END : PROG

Press ADD/DLT.

**4** Press PROG twice to exit this mode.

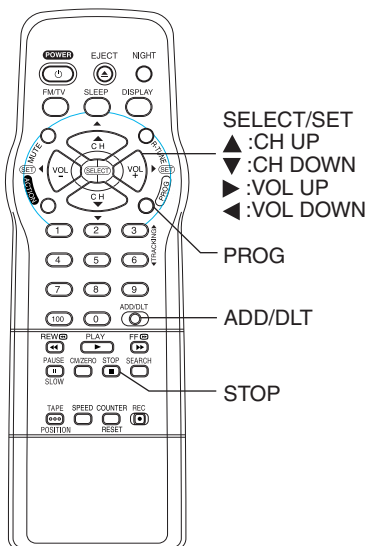

### Notes

- 2 minutes before Timer recording is performed, "PLEASE PREPARE FOR TIMER REC" appears and/or the PROG TIMER Indicator flashes. Be sure a cassette with record tab is loaded and the unit is in Stop mode.
- If the start times of two programs overlap, the lower numbered program will have priority.
- If the start time for a Timer Recording comes up during a normal recording or One Touch Recording (page 12), the Timer Recording will not be performed.
- If there is a power interruption of more than one minute, the recording may not be performed or continued.
- If "INCOMPLETE" appears after all items have been set, check all entries and make necessary corrections.

# Tape Operation

## Search System is ...

Each time a recording is made, an invisible index mark is placed on the tape. When timer recordings are made, program index and information are also included. These index marks can be used to access or scan recordings.

### Index Search

Go directly to the desired recording.

1

INDEX SEARCH  
ENTER INDEX NUMBER:1  
USING 1-9 KEYS  
  
FORWARD SEARCH:FF  
REVERSE SEARCH:REW  
  
EXIT :SEARCH

Press **SEARCH** in Playback or Stop mode to display INDEX SEARCH screen, and then **press number keys** to select the recording number.

- To calculate number, see below.

Press **FF** or **REW** to start search.

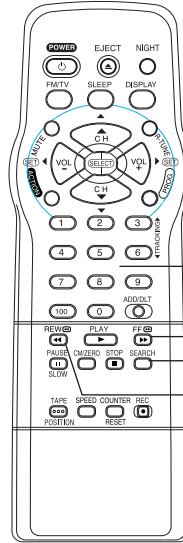

NUMBER Keys

FF  
SEARCH

REW

2

INDEX SEARCH  
  
FORWARD SEARCH:FF  
REVERSE SEARCH:REW

Play begins at search end. To search forward or back 1 index, **press FF or REW** while screen left in displayed (10 sec.).

To cancel, press **PLAY**.

### ■ To calculate the Index Number

#### Example 1:

To go to rec. 2 from rec. 4, enter 3 and press REW.

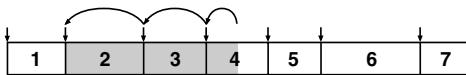

#### Example 2:

To go to rec. 6 from rec. 2, enter 4 and press FF.

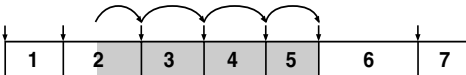

NOTE: ↓ indicates start points of each recording.

### Notes

- Make each entry within 10 seconds, or the Index Search mode will be canceled.
- If Index Search is started very close to an index mark, that index mark may not be counted in the search.

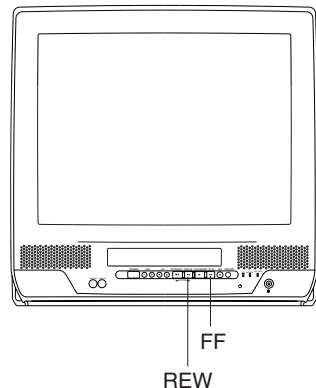

FF  
REW



## Auto Operation Functions

### ■ Auto Shut Off

No broadcast signal in TV (Only when Weak Signal Display is set to OFF), blank tape is Played for 5 minutes  
→ Power turns off

- This feature is canceled if any button is pressed during above mode.

### ■ Auto Playback

Insert a tape in Power off mode  
→ Power turns on

- Playback begins if tape has no record tab.

### ■ Auto Rewind

Tape reaches its end  
→ Rewind → Stop

### ■ Playback Auto Eject (Repeat Play is "OFF")

Tape with no record tab reaches its end  
Rewind → Stop → Eject

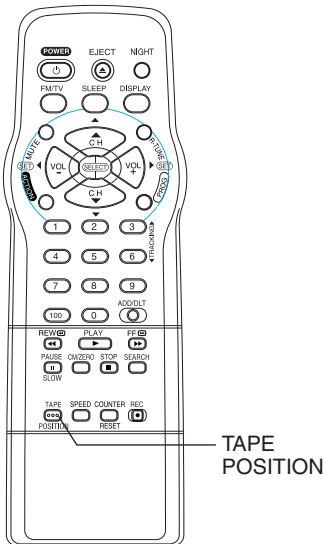

## Tape Position Display

To find out present tape position.

**Tape position is displayed for VHS-C Cassettes type, tapes under 30 minutes, and some other tapes, but the position is not correct.**

### 1 Press TAPE POSITION to detect current tape position.

DETECTING TAPE POSITION

- "DETECTING TAPE POSITION" only appears the first time a cassette is inserted and it takes several seconds for correct indication to appear.

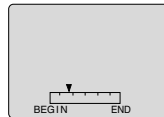

- The present tape position indication is displayed.

### 2 Press TAPE POSITION (or wait 5 seconds) to return to the normal screen.

# Tape Operation (continued)

## Zero Search

To quickly return to a specific tape counter location.

**1** Press **COUNTER RESET** during playback to display the Counter.

**2**  Press **COUNTER RESET** at the desired position to reset to "0:00:00."

**3** Continue playback, rewind, or fast forward.

**4** Press **STOP**.

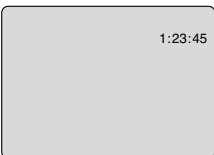
**5**  Press **CM/ZERO** in stop mode to start **ZERO SEARCH**.

- Unit goes into FF or REW mode and stops at the last point the Counter was set to 0:00:00.

## Commercial Skip

By pressing the **CM/ZERO** button in Playback mode you can skip over 1 to 3 minutes of recorded tape in just a few seconds.

Press **CM/ZERO** repeatedly to select skip time in Play mode.

- No indication appears.

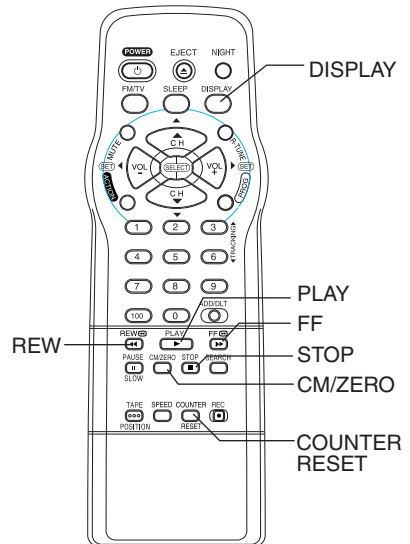
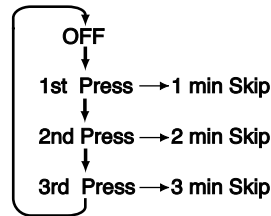

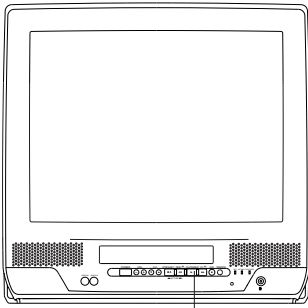

PLAY/REPEAT

## Repeat Play

Set to see a recording over and over.

PLAY  
REPEAT ON

In **PLAY** mode, **press PLAY/REPEAT** on the unit to

PLAY  
REPEAT OFF

Repeat above to turn "OFF."

### Note

- Playback repeats when tape end is reached or unrecorded portion over 30 seconds is detected.

# Special VCR Features

## Weak Signal Display ON/OFF

When "ON" is selected, the picture is displayed even when a broadcast signal is weak or non-existent.

**1** Press **ACTION** to display MAIN MENU.

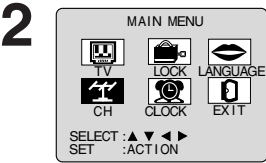

- 1) Press **▲▼◀▶** to select "CH."
- 2) Press **ACTION** to display SET UP CHANNEL screen.

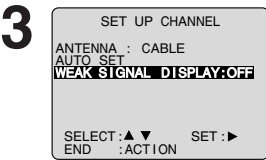

- 1) Press **▲▼** to select WEAK SIGNAL DISPLAY .
- 2) Press **▶** to set "ON" or "OFF."

### Notes

- "ON" = Picture is displayed regardless of signal condition, and may not always be clearly visible.  
"OFF" = Screen turns solid blue when signal is absent or weak.
- If unit is connected to equipment which has blue back feature, selecting "ON" will have no effect on the other equipment.

**4** Press **ACTION** twice to return to the normal screen.

## VCR Lock

All operations are prohibited except Timer recording and tape eject. Useful for families with small children.

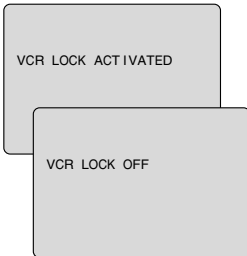

In stop mode, **hold down REC** on the unit without a cassette inserted for 7 seconds to turn "ON." Please ignore NO CASSETTE warning.

Repeat above with or without cassette to turn "OFF."

- VCR Lock is canceled automatically after about 24 hours if clock is set.

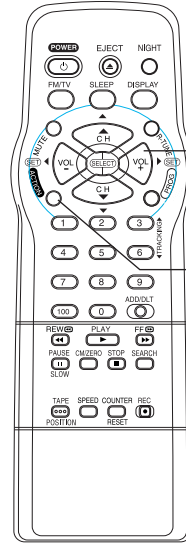

SELECT/SET  
▲:CH UP  
▼:CH DOWN  
▶:VOL UP  
◀:VOL DOWN

ACTION

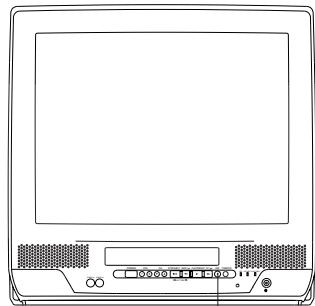

REC

# V-Chip Control Feature

## Process of V-Chip Control Feature

**Enter Code** → **Setup** → **Blocking**

## V-Chip Control Feature is...

This unit has a built-in V-Chip Control which allows you to block unwanted TV usage based on US MOVIES and US TV PROGRAMS Ratings.

## Enter Secret Code

A 4-digit code must be entered to view a blocked program or change rating settings.

**1** Press **ACTION** to display MAIN MENU.

**2**

- 1) Press **▲▼◀▶** to select "LOCK."
- 2) Press **ACTION** to display screen.

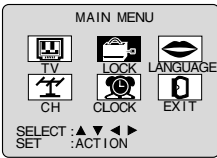

**3**

- 1) Press **NUMBER** keys to enter your secret code.
- 2) Enter same code again for confirmation.

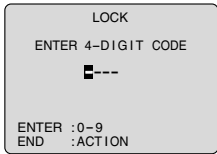

### To Make Corrections

Press **◀** repeatedly to move the cursor. Press number keys to make the correction.

- Step 2) not necessary when changing rating or secret code.
- Take care that you are not observed entering the secret code.

**4**

Press **▶** to display US Ratings menu (see page 30).  
Or  
Press **ACTION** twice to exit.

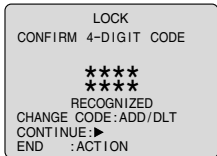

## Changing your secret code

- You will need your current code. Do steps 1 ~ 3. In step 4, press **ADD/HLT** to clear current code. Repeat steps 3 and 4 to enter new code.

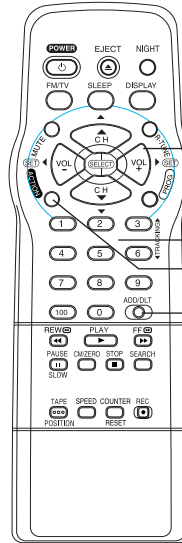

- SELECT/SET**  
**▲** :CH UP  
**▼** :CH DOWN  
**▶** :VOL UP  
**◀** :VOL DOWN
- NUMBER** Keys  
**ACTION**
- ADD/HLT**

## Notes

- DO NOT forget your secret code.
- Once ratings are set, restricted tapes or programs cannot be accessed unless the secret code is entered.

# V-Chip Control Feature (continued)

If LOCK menu is not displayed, do "Enter Secret Code" steps on page 29.

## Process of V-Chip Control Feature



### Setup US MOVIES Ratings

1

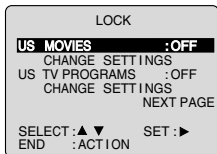

- 1) Press ▲▼ to select US MOVIES.
- 2) Press ► to set "ON" or "OFF."

- "ON" → V-Chip Control is activated.
- "OFF" → V-Chip Control is deactivated.

#### Note

- "NEXT PAGE" displays CANADIAN V-Chip setting menu. Not necessary except when viewing Canadian tapes or broadcasts.

### Setup US TV PROGRAMS Ratings

1

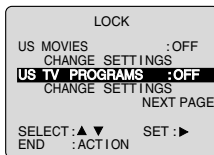

- 1) Press ▲▼ to select US TV PROGRAMS.
- 2) Press ► to set "ON" or "OFF."

- "ON" → V-Chip Control is activated.
- "OFF" → V-Chip Control is deactivated.

#### Note

- "NEXT PAGE" displays CANADIAN V-Chip setting menu. Not necessary except when viewing Canadian tapes or broadcasts.

2

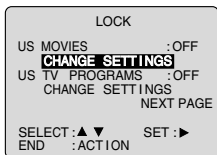

- 1) Press ▲▼ to select CHANGE SETTINGS.
- 2) Press ► to display screen.

2

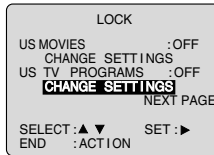

- 1) Press ▲▼ to select CHANGE SETTINGS.
- 2) Press ► to display screen.

3

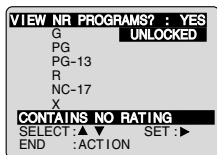

- 1) Press ▲▼ to select VIEW NR PROGRAMS?.
- 2) Press ► to set "YES" or "NO."

#### NR (Not Rated) PROGRAMS

Some movies, such as old movies or foreign movies usually have no ratings.

3

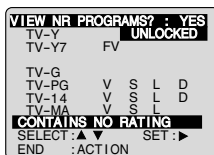

- 1) Press ▲▼ to select VIEW NR PROGRAMS?.
- 2) Press ► to set "YES" or "NO."

#### NR (Not Rated) PROGRAMS

Some TV shows, such as news, sports, weather, bulletins, emergency information usually have no ratings.

4

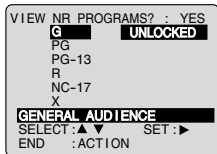

- Press ▲▼ to select and ► to set ratings to be blocked. (See ratings chart next page.)

- 5 Press ACTION to redisplay LOCK menu and continue with US TV PROGRAMS Ratings Setup (this page). Or, press ACTION three times to exit.

4

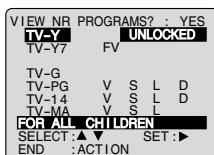

- Press ▲▼ to select and ► to set ratings to be blocked. (See ratings charts next page.)

#### Note

- You may select from standard TV ratings (chart 1), or customize to a specific content rating (chart 2).

- Ratings highlighted in Green will be blocked. Ratings in white letters will not be blocked.

- 5 Press ACTION three times to exit this mode.

## Process of V-Chip Control Feature

Enter Code → Setup → Blocking

### Blocking Message

<When V-Chip Control is activated>

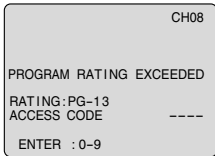

- If a program or movie exceeds the ratings you have set, a message will appear on a black background and sound is muted.

### To View a Blocked Program / Movie

#### [Temporarily Deactivate V-Chip Control]

Enter your secret code (ACCESS CODE) in the Blocking Message screen.

- V-Chip Control is reactivated when power is turned off or power failure occurs.

#### [Deactivate V-Chip Control]

Enter your secret code (steps 1-3 page 29). Then, set US MOVIES and/or US TV PROGRAMS to "OFF" using ▲▼ and ► keys. (Ratings set on page 30 is retained and will be in effect when V-Chip Control is activated again.)

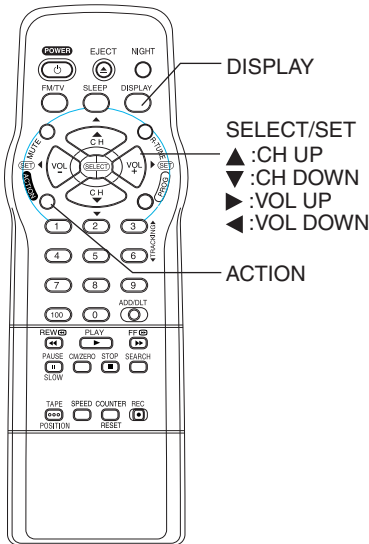

### US MOVIES RATINGS

<b>G</b>	<b>GENERAL AUDIENCE:</b> All ages admitted.
<b>PG</b>	<b>PARENTAL GUIDANCE:</b> Some material may not be suitable for children.
<b>PG-13</b>	<b>PARENTS CAUTIONED:</b> Some material may be inappropriate for children under 13.
<b>R</b>	<b>RESTRICTED:</b> Children under 17 must be accompanied by a parent or adult.
<b>NC-17</b>	<b>OVER AGE 17 ONLY:</b> No one 17 and under admitted.
<b>X</b>	<b>ADULTS ONLY:</b>

### US TV PROGRAMS RATINGS: Chart 1

<b>TV-Y</b>	<b>FOR ALL CHILDREN:</b> Content specifically geared to young viewers ages 2-6.
<b>TV-Y7</b>	<b>FOR AGE 7 AND OLDER:</b> May contain mild physical or comedic violence which may frighten children under 7.
<b>TV-G</b>	<b>GENERAL AUDIENCE:</b> Contains little or no violence, strong language, or sexual dialogue or situations.
<b>TV-PG</b>	<b>PARENTAL GUIDANCE:</b> May contain infrequent coarse language, limited violence, some suggestive sexual dialogue and situations.
<b>TV-14</b>	<b>PARENTS CAUTIONED:</b> May contain sophisticated themes, sexual situations, strong language, and more intense violence.
<b>TV-MA</b>	<b>MATURE AUDIENCE:</b> May contain mature themes, profane language, graphic violence, and sexual situations.

Advanced Operation

### US TV PROGRAMS RATINGS: Chart 2

<b>FV</b>	Fantasy Violence
<b>V</b>	Violence
<b>S</b>	Sexual Situations
<b>L</b>	Adult Language
<b>D</b>	Sexually Suggestive Dialogue

# On-Screen Display (OSD)

## VCR Status & Clock Display

Press **DISPLAY** to display or remove the overlay.

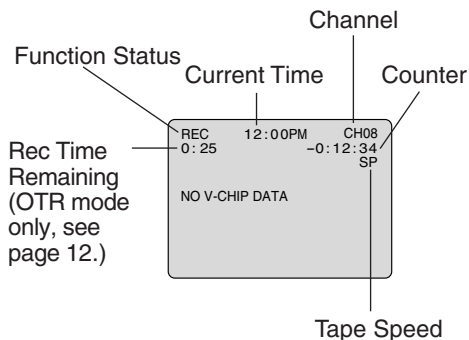

## Blue Screen Display

Whenever a blank section of a tape comes up in Play mode, or when the selected channel has no broadcast signal with the Weak Signal Display set to "OFF" (see page 28), the screen will turn solid blue.

## Channel & Function Display

When a function button is pressed (PLAY, FF, etc.) or you change channels, the unit mode or channel number will be displayed.

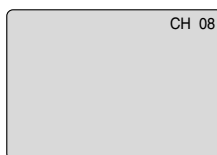

## Warning and Instruction Displays

These displays will alert you to a missed operation or provide further instructions.

OSD	CAUTION	Page
PLEASE SET CLOCK BY PRESSING ACTION KEY	If you attempt to set or review a Timer Recording, or set the On-Timer and the Clock is not set...	8 - 11
CHECK CASSETTE RECORD TAB	If you press REC, and a cassette is inserted with no record tab...	3, 12
TO CANCEL TIMER REC HOLD DOWN STOP KEY FOR APPROX 3 SEC	If you press STOP during a Timer Recording...	23
NO CASSETTE	If you press PLAY, FF, REW, or REC without a cassette inserted...	12
PLEASE PREPARE FOR TIMER REC	If the unit is not in Stop mode or a cassette with record tab is not inserted two minutes before a Timer Recording is about to begin...	22 - 23
VIDEO HEADS MAY NEED CLEANING PLEASE INSERT HEAD CLEANING CASSETTE OR REFER TO MANUAL END: PLAY	If head cleaning becomes necessary while playing back a tape...	4
VCR LOCK ACTIVATED	If you press a function button other than STOP/EJECT or POWER while the unit is in VCR Lock mode...	28



# Before Requesting Service

Check the following points once again if you are having trouble with your unit.

Power	CORRECTION
No power...	<ul style="list-style-type: none"> <li>• Completely insert Power Plug into an AC outlet.</li> <li>• Set POWER button to ON.</li> </ul>
Monitor	CORRECTION
No picture or sound...	<ul style="list-style-type: none"> <li>• Make sure your antenna system (TV or CABLE), is correctly set. (P.8)</li> <li>• Completely insert Power Plug into an AC outlet.</li> <li>• Set POWER button to ON.</li> </ul>
Poor picture with normal sound...	<ul style="list-style-type: none"> <li>• Adjust BRIGHTNESS, SHARPNESS, and PICTURE controls in the SET UP TV menu. (P.15)</li> </ul>
Poor sound with normal picture...	<ul style="list-style-type: none"> <li>• Adjust VOLUME control. (P.14)</li> </ul>
Poor TV reception...	<ul style="list-style-type: none"> <li>• Adjust SHARPNESS and PICTURE controls in the SET UP TV menu. (P.15)</li> </ul>
No color or poor color...	<ul style="list-style-type: none"> <li>• Adjust TINT and COLOR controls in the SET UP TV menu. (P.15)</li> </ul>
Ghost (multiple) images...	<ul style="list-style-type: none"> <li>• Install a directional antenna.</li> </ul>
TV programs cannot be watched...	<ul style="list-style-type: none"> <li>• Make sure the selected channel is in unit's memory. (P.10, 11)</li> </ul>
Channel cannot be selected...	<ul style="list-style-type: none"> <li>• Only the channel being recorded can be viewed on this unit.</li> </ul>
VCR	CORRECTION
TV program cannot be recorded...	<ul style="list-style-type: none"> <li>• Make sure your antenna system (TV or CABLE), is correctly set. (P.8)</li> <li>• Make sure cassette record tab is intact. (P.3)</li> </ul>
Timer recording cannot be performed...	<ul style="list-style-type: none"> <li>• Check that clock is set to current time and date.</li> <li>• Make sure DSS/CABLE box (if used) is left on and tuned to channel to be recorded.</li> <li>• Set recording Start/Stop times correctly. (P.22-23)</li> <li>• Timer recording may not be performed or continued if a power interruption of more than 1 minute occurs before or during a Timer Recording, even after power is restored.</li> </ul>
No playback picture, or the playback picture is noisy or contains streaks...	<ul style="list-style-type: none"> <li>• Adjust TRACKING control in either direction. (P.4)</li> <li>• Try Head Cleaning. (P.4)</li> </ul>
VCR cannot be controlled...	<ul style="list-style-type: none"> <li>• Make sure VCR LOCK is set to off. (P.28)</li> <li>• Make sure unit is not in a Timer Record operation.</li> </ul>
Remote Control	CORRECTION
Unit cannot be controlled...	<ul style="list-style-type: none"> <li>• Aim remote at remote sensor on unit (P.7) so that signal is unobstructed.</li> <li>• Inspect the remote batteries. (P.3)</li> <li>• Make sure VCR LOCK is set to off. (P.28)</li> <li>• Exposing unit remote sensor to direct fluorescent or outdoor light may cause signal interference.</li> </ul>
ACTION, PROG and FM/TV buttons cannot be selected...	<ul style="list-style-type: none"> <li>• Check remote batteries.</li> </ul>
Miscellaneous	CORRECTION
Video cassette cannot be inserted...	<ul style="list-style-type: none"> <li>• Insert the cassette window side up; record tab facing you.</li> </ul>
Video cassette cannot be removed...	<ul style="list-style-type: none"> <li>• Completely insert Power Plug into an AC outlet.</li> </ul>
Tape cannot be ejected or inserted...	<ul style="list-style-type: none"> <li>• Try ejecting or inserting the tape again after turning POWER off, then back on.</li> </ul>
Video cassette ejects when a recording is started, or the power is turned off for timer recording...	<ul style="list-style-type: none"> <li>• Make sure cassette record tab is intact. (P.3)</li> </ul>
In Stop mode, the VCR motor (CYLINDER) continues to rotate...	<ul style="list-style-type: none"> <li>• To enable Quick Play mechanism, the VCR cylinder will rotate for about 3 minutes. This reduces response time from Stop to Play mode and from Play to Rewind Search mode.</li> </ul>
VCR cannot be controlled...	<ul style="list-style-type: none"> <li>• Make sure VCR LOCK is set to off. (P.28)</li> </ul>

If you cannot resolve the problem, please call the Customer Satisfaction Center for product assistance at 1-800-211-PANA(7262).

To locate an authorized servicenter call toll free 1-800-211-PANA(7262) or send e-mail to : [consumerproducts@panasonic.com](mailto:consumerproducts@panasonic.com).

# Limited Warranty

PANASONIC CONSUMER ELECTRONICS  
COMPANY, DIVISION OF MATSUSHITA ELECTRIC  
CORPORATION OF AMERICA  
One Panasonic Way Secaucus, New Jersey 07094

PANASONIC SALES COMPANY, DIVISION OF  
MATSUSHITA ELECTRIC OF PUERTO RICO, INC.,  
AVE. 65 de Infantería, Km. 9.5 San Gabriel Industrial  
Park, Carolina, Puerto Rico 00985

## Panasonic/Quasar Video Products Limited Warranty

### Limited Warranty Coverage

If your product does not work properly because of a defect in materials or workmanship, Panasonic Consumer Electronics Company or Panasonic Sales Company (collectively referred to as "the warrantor") will, for the length of the period indicated on the chart below, which starts with the date of original purchase ("warranty period"), at its option either (a) repair your product with new or refurbished parts, or (b) replace it with a new or a refurbished product. The decision to repair or replace will be made by the warrantor.

Product	Parts	Labor	Service	Contact Number
Camcorder	One (1) Year (except CCD Image Sensor) CCD Image Sensor - 6 (Six) Months	Ninety (90) Days  Ninety (90) Days	Carry-In or Mail-In	1-800-211-PANA(7262)
DVD/VCR Deck, A/V Mixer	One (1) Year	Ninety (90) Days	Carry-In or Mail-In	1-800-211-PANA(7262)
TV/VCR, TV/DVD, TV/DVD/VCR Combination	One (1) Year (except CRT) CRT - Two (2) Years	Ninety (90) Days  Ninety (90) Days	Carry-In: 21" CRT and Smaller In-Home or Carry-In: 22" CRT and Larger	1-800-211-PANA(7262)
TV/HDR Combination	One (1) Year (except CRT) CRT - Two (2) Years	Ninety (90) Days  Ninety (90) Days	In-Home or Carry-In	1-888-843-9788
Rechargeable Batteries (in exchange for defective item)	Ten (10) Days	Not Applicable	Carry-In or Mail-In	1-800-211-PANA(7262)
Tape (in exchange for defective item)	Five (5) Days	Not Applicable	Carry-In or Mail-In	1-800-211-PANA(7262)
Memory Cards (in exchange for defective item)	Ninety (90) Days	Not Applicable	Carry-In or Mail-In	1-800-211-PANA(7262)

During the "Labor" warranty period there will be no charge for labor. During the "Parts" warranty period, there will be no charge for parts. You must carry-in or mail-in your product or arrange for in-home service, as applicable, during the warranty period.

If non-rechargeable batteries are included, they are not warranted. This warranty only applies to products purchased and serviced in the United States or Puerto Rico. This warranty is extended only to the original purchaser of a new product which was not sold "as is." A purchase receipt or other proof of the original purchase date is required for warranty service.

### Carry-In, Mail-in or In-Home Service

For Carry-In, Mail-In or In-Home Service (as applicable) in the United States call toll free contact number listed above or visit Panasonic Web Site: <http://www.panasonic.com>

For assistance in Puerto Rico call Panasonic Sales Company (787)-750-4300 or fax (787)-768-2910.

In-Home service, if applicable, requires clear, complete and easy access to the product by the authorized servicer and does not include removal or re-installation of an installed product. It is possible that certain in-home repairs will not be completed in-home, but will require that the product, or parts of the product, be removed for shop diagnosis and/or repair and then returned.

### Limited Warranty Limits And Exclusions

This warranty ONLY COVERS failures due to defects in materials or workmanship, and DOES NOT COVER normal wear and tear or cosmetic damage, nor does it cover markings or retained images on the picture tube resulting from viewing fixed images (including, among other things, letterbox pictures on standard 4:3 screen TV's, or non-expanded standard 4:3 pictures on wide screen TV's, or onscreen data in a stationary and fixed location). The warranty ALSO DOES NOT COVER damages which occurred in shipment, or failures which are caused by products not supplied by the warrantor, or failures which result from accidents, misuse, abuse, neglect, mishandling, misapplication, alteration, faulty installation, set-up adjustments, misadjustment of consumer controls, improper maintenance, power line surge, lightning damage, modification, or commercial use (such as in a hotel, office, restaurant, or other business), rental use of the product, service by anyone other than a Factory Servicenter or other Authorized Servicer, or damage that is attributable to acts of God.

**THERE ARE NO EXPRESS WARRANTIES EXCEPT AS LISTED UNDER "LIMITED WARRANTY COVERAGE." THE WARRANTOR IS NOT LIABLE FOR INCIDENTAL OR CONSEQUENTIAL DAMAGES RESULTING FROM THE USE OF THIS PRODUCT, OR ARISING OUT OF ANY BREACH OF THIS WARRANTY.** (As examples, this excludes damages for lost time, cost of having someone remove or re-install an installed unit if applicable, or travel to and from the servicer, loss of media or images, data or other memory or recorded content. The items listed are not exclusive, but are for illustration only.)

**ALL EXPRESS AND IMPLIED WARRANTIES, INCLUDING THE WARRANTY OF MERCHANTABILITY, ARE LIMITED TO THE PERIOD OF THE LIMITED WARRANTY.**

Some states do not allow the exclusion or limitation of incidental or consequential damages, or limitations on how long an implied warranty lasts, so the exclusions may not apply to you.

This warranty gives you specific legal rights and you may also have other rights which vary from state to state. If a problem with this product develops during or after the warranty period, you may contact your dealer or Servicenter. If the problem is not handled to your satisfaction, then write to the warrantor's Consumer Affairs Department at the addresses listed for the warrantor.

**PARTS AND SERVICE (INCLUDING COST OF AN IN-HOME SERVICE CALL, WHERE APPLICABLE) WHICH ARE NOT COVERED BY THIS LIMITED WARRANTY ARE YOUR RESPONSIBILITY.**

## Customer Services Directory

*For Product Information, Operating Assistance, Literature Request, Dealer Locations, and all Customer Service inquiries please contact:  
1-800-211-PANA (7262), Monday-Friday 9 am-9 pm; Saturday-Sunday 9 am-7 pm, EST. or send e-mail : [consumerproducts@panasonic.com](mailto:consumerproducts@panasonic.com)  
For hearing or speech impaired TTY users, TTY : 1-877-833-8855*

*Web Site: <http://www.panasonic.com>  
You can purchase parts, accessories or locate your nearest servicenter by visiting our Web Site.*

### **Accessory Purchases:**

**1-800-332-5368 (Customer Orders Only)**  
For hearing or speech impaired TTY users, TTY : 1-866-605-1277  
Panasonic Services Company 20421 84th Avenue South, Kent, WA 98032  
(Monday-Friday 6 am-5 pm; Saturday 6 am-10:30 am, PST)  
(Visa, MasterCard, Discover Card, American Express, Check)

### **Service in Puerto Rico**

**Matsushita Electric of Puerto Rico, Inc. Panasonic Sales Company/ Factory Servicenter:**

**Ave. 65 de Infantería, Km. 9.5, San Gabriel Industrial Park,  
Carolina, Puerto Rico 00985  
Phone (787)750-4300 Fax (787)768-2910**

As of August 2002

# Spanish Quick Use Guide/Guía para rápida consulta

## Connexiones/Configuración Inicial

Conecte por favor todas las conexiones del cable o de la antena antes de turing potencia.

### Conectando

#### Para Ant./Cable

Conecte Ant./Cable a la entrada de antena de la TV (VHF/UHF).

#### Para Sistema Digital de Satelite (DSS)/ Convertidor de cable

Conecte la salida del convertidor de cable la "VHF/UHF" con el RF cable.

## Realizando Configuración Inicial

- 1 Presione COMBO para mode del combo. Tape el cable electrico de la unidad en el enchufe de pared de la CA. POWER de la prensa en el telecontrol o la unidad. La unidad se adelanta y comienzo auto del canal y del reloj.

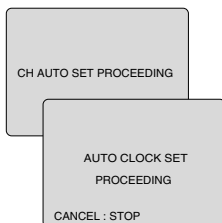

Si usa convertidor de cable, enciendala y seleccione el Servicio Publico de Canales de Television (PBS) en su horario de uso o tiempo de su zona. Si utiliza receptor DSS este debe de estar apagado.

2

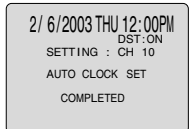

Selecciones se realizaran automaticamente cuando la configuracion termine, la pantalla siguiente aparecera.

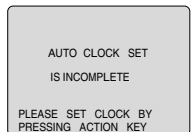

Si "AUTO CLOCK SET IS INCOMPLETE" aparece en pantalla, coloque el tiempo usando el procedimiento manual (MANUAL CLOCK SET), vealo enseguida.

### Nota

- Los botones de funciones son inoperantes durante la Configuración inicial.
- Para retirar un cassette durante el Ajuste automático, pulse EJECT dos veces en el control remoto o STOP dos veces en el VCR. En este caso, los ajustes se deben realizar manualmente. (Vea la p.10 de Libro de operaciones avanzadas).
- Dependiendo de las condiciones, puede que el Ajuste automático del reloj tarde más de 30 minutos. En ese caso, pulse STOP para detener la configuración y realice los ajustes manualmente. (Vea la p.10 de Libro de operaciones avanzadas).

## Ajuste Manual del Reloj

Si el ajuste automático del reloj no se ha completado, ajuste el reloj manualmente de la siguiente manera:

- 1) Presione la tecla ACTION en el control remoto para visualizar la pantalla del menú RELOJ.
- 2) Presione ▲▼ para seleccionar el mes y ► para ajustar. De la misma forma, seleccione y ajuste la fecha, año, hora y DST (Hora de Verano).
- 3) Presione dos veces la tecla ACTION para poner el RELOJ en marcha y salir.

## Ajustar de nuevo el reloj

- 1 Presione ACTION para exhiba el menú.

2

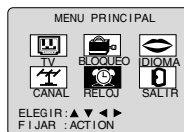

Presione ▲▼▶◀ para seleccionar "RELOJ," y luego presione ACTION.

3

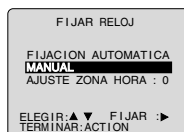

Presione ▲▼ para seleccionar "MANUAL" y luego presione ►.

4

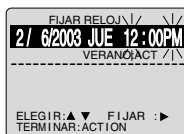

Presione ▲▼ y ◀► para seleccionar y ajustar la hora y la fecha.

5

Presione ACTION dos veces para que el reloj comience a funcionar y salir desde este modo.

## Operaciones básicas para la reproducción

- 1 Inserte un casete.**
  - El videograbador combinado se enciende automáticamente.
- 2 Presione PLAY.**
  - La reproducción comienza automáticamente si el casete no tiene la lengüeta para prevención de grabación.
  - Para encontrar una escena en particular
    - Búsqueda hacia adelante → Presione FF
    - Búsqueda hacia atrás → Presione REW
  - Para ver una imagen fija (congelada) → Presione PAUSE/SLOW
  - Para ver en cámara lenta → Mantenga pulsado el botón PAUSE/SLOW en el modo de imagen fija
  - Para ver imágenes cuadro a cuadro → Presione PAUSE/SLOW en el modo de imagen fija
  - Para parar → Presione STOP
  - Para rebobinar la cinta → Presione REW
  - Para hacer avanzar la cinta rápidamente → Presione FF
  - Para expulsar la cinta → Presione EJECT en el control remoto o STOP/EJECT en el videograbador combinado

## Operaciones básicas para la grabación

- 1 Inserte un casete con la lengüeta para prevención de grabado.**
  - El videograbador combinado se enciende automáticamente.
- 2 Seleccione el canal.**

Presione CH ▲▼ o las teclas numéricas correspondiente.
- 3 Seleccione la velocidad de grabación.**

Presione SPEED.

  - SP = reproducción normal
  - LP = reproducción larga
  - SLP = reproducción super larga

La velocidad seleccionada debe aparecer en la pantalla.
- 4 Comience la grabación.**

Presione REC.

  - Para editar partes no deseadas de una grabación, presione PAUSE/SLOW para hacer una pausa durante la grabación.
  - No podrá ver otro canal durante la grabación.
  - Para parar → Presione STOP.
  - El videograbador combinado deja de grabar a una hora prefijada.** (Grabación de un toque)
 

Presione REC repetidamente para ajustar la hora de grabación (30 min - 4 horas.)

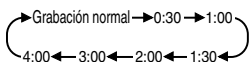

## Grabación con temporizador

- 1 Exhiba FIJAR PROGRAMACION.**

Presione PROG.



- 1 Exhiba TEMPORIZADOR.**
  - Presione ▲▼ para seleccionar.
  - Presione ► para exhibir.

- Si ya existe un programa en la memoria, presione ▲▼ y ► para seleccionar un número de programa sin usar.



- 3 Ajuste la fecha de grabación.**
  - Presione ▲▼ para seleccionar.
  - Presione ► o ◀ para ajustar.

- 1 - 31 = Grabación única
- DIARIO = a la misma hora de lunes a viernes
- SEMANAL = a la misma hora una vez a la semana

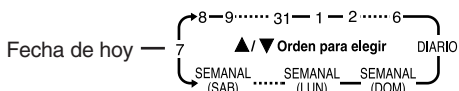

- Repita el paso 3 para ajustar: hora de comienzo, hora de parada, canal (o LINEA para una fuente exterior), velocidad (SP, LP, SLP)

- 4 Termine el programa.**

Presione PROG.

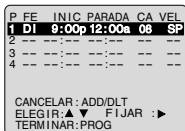

- Para introducir más programas.** presione ▲▼ y ► para seleccionar y ajustar el número de programa en blanco, y luego repita los pasos 3 y 4.

- 5 Salga de este modo.**

Presione PROG dos veces.

  - Si está usando un decodificador de TV cable, asegúrese que se encuentra en el canal deseado y que la alimentación queda conectada para grabar con temporizador.
  - El indicador PROG TIMER se enciende en el videograbador combinado.

# NOTES

# NOTES

# Index

<b>A</b>	
Accessories .....	3
Audio Mute .....	14
Auto Operation Functions .....	25
<b>B</b>	
Before Requesting Service .....	33
Blocking Message .....	31
Blue Screen Display .....	32
<b>C</b>	
Caption On Mute Feature .....	19
Channel & Function Display .....	32
Channel (SET UP CHANNEL) .....	10
Clock (SET CLOCK) .....	10
Closed Caption Mode Feature .....	18
Commercial Skip .....	26
Connections .....	8
Copy Your Tapes (Dubbing) .....	13
Customer Services Directory .....	35
<b>D</b>	
DST (Daylight Saving Time) .....	4
<b>E</b>	
Eject Tape .....	12
Enter Secret Code .....	29
<b>F</b>	
Fast Forward .....	12
Features for a Quality Picture .....	4
FM Radio .....	20-21
Forward Search .....	12
Frame by Frame Advance .....	12
Front Panel Indicators .....	7
<b>H</b>	
Head Cleaning .....	4
<b>I</b>	
Important Safeguards and Precautions .....	2
Index Search .....	24
Initial Setup .....	8
Instant Alarm .....	17
<b>L</b>	
Language .....	10
Limited Warranty .....	34-35
Loading the Batteries .....	3
Location of Controls .....	6-7
<b>N</b>	
NIGHT Mode .....	14
<b>O</b>	
ON-TIMER with Alarm .....	16
One Touch Recording .....	12
<b>P</b>	
Phones .....	14
Picture Adjustment .....	15
Playback .....	12
<b>R</b>	
Rapid Tune .....	14
Rec(ord) .....	12
Record/Playback Speed Settings .....	4
Remote Control Buttons .....	6
Repeat Play .....	27
Reset all unit Memory Functions .....	9
Reverse Search .....	12
Rewind .....	12
<b>S</b>	
Selecting Input Mode .....	13
Sleep Timer .....	17
Slow Motion .....	12
Spanish Quick Use Guide .....	36-37
Special VCR Features .....	28
Specifications .....	4
Still (Freeze) Picture .....	12
Stop .....	12
<b>T</b>	
Tape Erasure Prevention .....	3
Tape Position Display .....	25
Timer Program Review, Replace, Clear .....	23
Timer Recording .....	22
Timer Recording Cancellation .....	23
Time Zone Adjust .....	11
TV Operation .....	14
TV Timer Features .....	16-17
<b>U</b>	
Unit, Front View .....	7
Unit, Rear View .....	7
Using the 100 key .....	14
US MOVIES RATINGS .....	31
US TV PROGRAMS RATINGS .....	31
<b>V</b>	
V-Chip Control Feature .....	29-31
VCR Lock .....	28
VCR Status & Clock Display .....	32
<b>W</b>	
Warning and Instruction Displays .....	32
Weak Signal Display ON/OFF .....	28
<b>Z</b>	
Zero Search .....	26

LSQT0665A

**Panasonic Consumer Electronics Company,**  
**Division of Matsushita Electric Corporation of America**  
One Panasonic Way Secaucus,  
New Jersey 07094

**Panasonic Sales Company ("PSC"),**  
**Division of Matsushita Electric of Puerto Rico, Inc.**  
Ave. 65 de Infanteria, Km. 9.5  
San Gabriel Industrial Park, Carolina, Puerto Rico 00985



Printed in Indonesia  
LSQT0665A  
S0103-0